

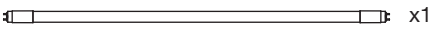

<p>Content:</p>  x1  x1 	<p>Dimension: *Dimensions in mm</p>  
---	--

EAN	W	lm	K	CRI	Ta (°C)	V	Hz	Dim	kg	L	W
8719157036634	14	1950	3000	80	-20~+45	40-70VAC	25K-70K	No	0.20	1212.5	27.8
8719157036641	14	2100	4000	80	-20~+45	40-70VAC	25K-70K	No	0.20	1212.5	27.8
8719157036658	14	2100	6500	80	-20~+45	40-70VAC	25K-70K	No	0.20	1212.5	27.8
8719157036665	20	2800	3000	80	-20~+45	40-70VAC	25K-70K	No	0.248	1513.1	27.8
8719157036672	20	3100	4000	80	-20~+45	40-70VAC	25K-70K	No	0.248	1513.1	27.8
8719157036689	20	3100	6500	80	-20~+45	40-70VAC	25K-70K	No	0.248	1513.1	27.8

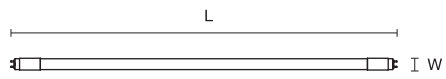
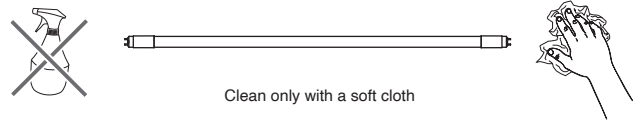
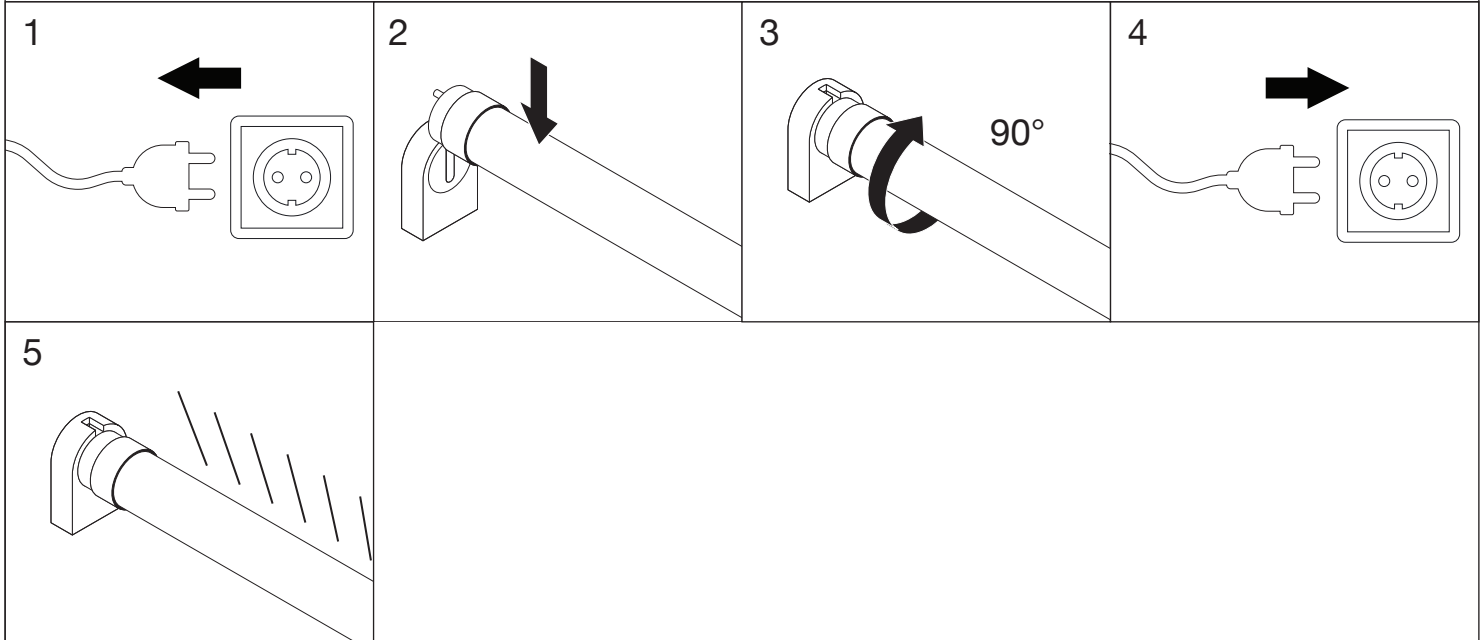

EN The luminaire shall be installed and maintained by a qualified electrician, in accordance with the national regulations in each country. The luminaire contains no replaceable parts. In case of the luminaire is damaged, it shall be exclusively replaced by the manufacturer or authorized dealer. Keep the operating manual for later use. The manufacturer is not responsible for the incorrect use and assembly of this product.

NL De armatuur dient te worden geïnstalleerd en onderhouden door een erkend installateur, in overeenstemming met de nationale regelgeving in het betreffende land. De armatuur bevat geen vervangbare onderdelen. Indien de armatuur is beschadigd dient deze enkel te worden vervangen door de fabrikant of door een erkende dealer. Bewaar de handleiding voor later gebruik. De fabrikant is niet verantwoordelijk voor onjuist gebruik en/of installatie van dit product.





DE Die Leuchte muss von einem qualifizierten Elektriker gemäß den nationalen Vorschriften in jedem Land installiert und gewartet werden. Die Leuchte enthält keine austauschbaren Teile. Falls die Leuchte beschädigt ist, wird sie ausschließlich durch den Hersteller oder den autorisierten Händler ersetzt. Bewahren Sie die Bedienungsanleitung für spätere Verwendung auf. Der Hersteller ist nicht verantwortlich für die unsachgemäße Verwendung und Montage dieses Produktes.

FR Le luminaire doit être installé et entretenu par un électricien qualifié, conformément à la réglementation nationale de chaque pays. Le luminaire ne contient pas de pièces remplaçables. Dans le cas où le luminaire est endommagé, il doit être remplacé exclusivement par le fabricant ou le revendeur agréé. Conservez le mode d'emploi pour une utilisation ultérieure. Le fabricant n'est pas responsable de l'utilisation et du montage incorrects de ce produit.





IT L'apparecchio deve essere installato e mantenuto da un elettricista qualificato seguendo le normative nazionali di riferimento. L'apparecchio non contiene parti sostituibili. In caso di rottura sarà sostituito esclusivamente dal produttore o da un rivenditore autorizzato. Conservate il manuale di installazione per eventuali utilizzi successivi. Il produttore non è responsabile per l'utilizzo ed il montaggio non corretto di tale apparecchio.

ES La luminaria debe de ser instalada y mantenida por un electricista cualificado, siguiendo las regulaciones nacionales de cada país. La luminaria contiene partes no reemplazables. En el caso de que la luminaria sea dañada, deberá ser reemplazada exclusivamente por el fabricante o distribuidor autorizado. Guarde el manual para usos posteriores. El fabricante no es responsable por el uso e instalación incorrecta de este producto.





EN

-  Lamp suitable for high frequency operation.
-  Lamp not suitable for emergency operation.
-  Lamp to be used in dry conditions or in a luminaire that provides protection.
-  Dimming not allowed.





NL

-  Lamp geschikt voor hoogfrequent gebruik.
-  Lamp niet geschikt voor noodverlichting.
-  Lamp dient gebruikt te worden in droge omstandigheden of in een armatuur die bescherming biedt.
-  Niet gebruiken met dimmers.





DE

-  Lampe geeignet für Hochfrequenzbetrieb.
-  Lampe nicht zur Notbeleuchtung geeignet.
-  Lampe muss unter trockenen Bedingungen oder in einer Leuchte verwendet werden die ausreichenden Schutz bietet.
-  Nicht mit dimmern verwenden.





FR

-  Lampe adaptée au fonctionnement à haute fréquence.
-  Lampe ne convenant pas à un fonctionnement de secours.
-  Lampe à utiliser dans des conditions sèches ou dans un luminaire offrant une p
-  Ne pas utiliser avec des variateurs.





IT

-  Lampada adatta al funzionamento ad alta frequenza.
-  Lampada non adatta al funzionamento di emergenza.
-  Usare all'asciutto o in un apparecchio che fornisce protezione.
-  Regolazione del flusso non consentita.

ES

-  Lámpara adecuada para funcionamiento en alta frecuencia.
-  Lámpara no adecuada para el funcionamiento de emergencia.
-  Lámpara para uso en condiciones secas o en una luminaria que propo
-  No se permite regulación.

SWEDISH

-  Lampa lämplig för högfrekvent drift.
-  Lampan är inte lämplig för nöddrift.
-  Lampa för användning i torra förhållanden eller i en armatur som ger skydd.
-  Dimning ej tillåten.



This lamp may not be suitable for use in all applications where a traditional fluorescent lamp has been used. The temperature range of this lamp is more restricted. In cases of doubt regarding the suitability of the application the manufacturer of this lamp should be consulted.



No modifications of the luminaire which the LED lamp is to be used with are to be made.



This lamp is designed for general lighting service (excluding for example explosive atmospheres).